

PHASE CONTROL THYRISTORS

Hockey Puk Version

Features

- Center amplifying gate
- Metal case with ceramic insulator
- International standard case A-24 (K-PUK)
- High profile hockey-puk

Typical Applications

- DC motor controls
- Controlled DC power supplies
- AC controllers

Major Ratings and Characteristics

Parameters	ST1230C..K	Units	
$I_{T(AV)}$	1745	A	
@ T_{hs}	55	°C	
$I_{T(RMS)}$	3200	A	
@ T_{hs}	25	°C	
I_{TSM}	@ 50Hz	33500	A
	@ 60Hz	35100	A
I^2t	@ 50Hz	5615	KA ² s
	@ 60Hz	5126	KA ² s
V_{DRM}/V_{RRM}	800 to 1600	V	
t_q	typical	200	μs
T_J	- 40 to 125	°C	

1745A

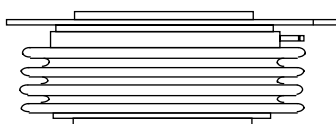

case style A-24 (K-PUK)

ST1230C..K Series

Bulletin I25194 rev. B 01/00

International
 Rectifier

ELECTRICAL SPECIFICATIONS

Voltage Ratings

Type number	Voltage Code	V_{DRM}/V_{RRM} , max. repetitive peak and off-state voltage V	V_{RSM} , maximum non-repetitive peak voltage V	I_{DRM}/I_{RRM} max. @ $T_J = T_J$ max mA
ST1230C..K	08	800	900	100
	12	1200	1300	
	14	1400	1500	
	16	1600	1700	

On-state Conduction

Parameter	ST1230C..K	Units	Conditions	
$I_{T(AV)}$ Max. average on-state current @ Heatsink temperature	1745 (710)	A	180° conduction, half sine wave double side (single side) cooled	
	55 (85)	°C		
$I_{T(RMS)}$ Max. RMS on-state current	3200	A	DC @ 25°C heatsink temperature double side cooled	
I_{TSM} Max. peak, one-cycle non-repetitive surge current	33500		t = 10ms	No voltage
	35100		t = 8.3ms	reapplied
	28200		t = 10ms	100% V_{RRM}
	29500	t = 8.3ms	reapplied	
I^2t Maximum I^2t for fusing	5615	KA ² s	t = 10ms	No voltage
	5126		t = 8.3ms	reapplied
	3971		t = 10ms	100% V_{RRM}
	3625		t = 8.3ms	reapplied
$I^2\sqrt{t}$ Maximum $I^2\sqrt{t}$ for fusing	56150	KA ² /s	t = 0.1 to 10ms, no voltage reapplied	
$V_{T(TO)1}$ Low level value of threshold voltage	0.93	V	$(16.7\% \times \pi \times I_{T(AV)} < I < \pi \times I_{T(AV)})$, $T_J = T_J$ max.	
$V_{T(TO)2}$ High level value of threshold voltage	1.02		$(I > \pi \times I_{T(AV)})$, $T_J = T_J$ max.	
r_{t1} Low level value of on-state slope resistance	0.17	mΩ	$(16.7\% \times \pi \times I_{T(AV)} < I < \pi \times I_{T(AV)})$, $T_J = T_J$ max.	
r_{t2} High level value of on-state slope resistance	0.16		$(I > \pi \times I_{T(AV)})$, $T_J = T_J$ max.	
V_{TM} Max. on-state voltage	1.62	V	$I_{pk} = 4000A$, $T_J = T_J$ max, $t_p = 10ms$ sine pulse	
I_H Maximum holding current	600	mA	$T_J = 25^\circ C$, anode supply 12V resistive load	
I_L Typical latching current	1000			

Switching

Parameter	ST1230C..K	Units	Conditions
di/dt Max. non-repetitive rate of rise of turned-on current	1000	A/μs	Gate drive 20V, 20Ω, $t_r \leq 1\mu s$ $T_J = T_J \text{ max}$, anode voltage $\leq 80\% V_{DRM}$
t_d Typical delay time	1.9	μs	Gate current 1A, $d_i/d_t = 1A/\mu s$ $V_d = 0.67\% V_{DRM}$, $T_J = 25^\circ C$
t_q Typical turn-off time	200		$I_{TM} = 550A$, $T_J = T_J \text{ max}$, $d_i/d_t = 40A/\mu s$, $V_R = 50V$ $dv/dt = 20V/\mu s$, Gate 0V 100Ω, $t_p = 500\mu s$

Blocking

Parameter	ST1230C..K	Units	Conditions
dv/dt Maximum critical rate of rise of off-state voltage	500	V/μs	$T_J = T_J \text{ max}$. linear to 80% rated V_{DRM}
I_{RRM} I_{DRM} Max. peak reverse and off-state leakage current	100	mA	$T_J = T_J \text{ max}$, rated V_{DRM}/V_{RRM} applied

Triggering

Parameter	ST1230C..K		Units	Conditions
P_{GM} Maximum peak gate power	16		W	$T_J = T_J \text{ max}$, $t_p \leq 5ms$
$P_{G(AV)}$ Maximum average gate power	3			
I_{GM} Max. peak positive gate current	3.0		A	$T_J = T_J \text{ max}$, $t_p \leq 5ms$
$+V_{GM}$ Maximum peak positive gate voltage	20		V	$T_J = T_J \text{ max}$, $t_p \leq 5ms$
$-V_{GM}$ Maximum peak negative gate voltage	5.0			
I_{GT} DC gate current required to trigger	TYP.	MAX.	mA	$T_J = -40^\circ C$ $T_J = 25^\circ C$ $T_J = 125^\circ C$ Max. required gate trigger/ current/ voltage are the lowest value which will trigger all units 12V anode-to-cathode applied
	200	-		
	100	200		
V_{GT} DC gate voltage required to trigger	1.4	-	V	$T_J = -40^\circ C$ $T_J = 25^\circ C$ $T_J = 125^\circ C$
	1.1	3.0		
	0.9	-		
I_{GD} DC gate current not to trigger	10		mA	Max. gate current/voltage not to trigger is the max. value which will not trigger any unit with rated V_{DRM} anode-to-cathode applied
V_{GD} DC gate voltage not to trigger	0.25		V	

ST1230C..K Series

Bulletin I25194 rev. B 01/00

International
IRF Rectifier

Thermal and Mechanical Specification

Parameter	ST1230C..K	Units	Conditions
T _J Max. operating temperature range	-40 to 125	°C	
T _{stg} Max. storage temperature range	-40 to 150		
R _{thJ-hs} Max. thermal resistance, junction to heatsink	0.042 0.021	K/W	DC operation single side cooled DC operation double side cooled
R _{thC-hs} Max. thermal resistance, case to heatsink	0.006 0.003	K/W	DC operation single side cooled DC operation double side cooled
F Mounting force, ± 10%	24500 (2500)	N (Kg)	
wt Approximate weight	425	g	
Case style	A-24 (K-PUK)		See Outline Table

ΔR_{thJ-hs} Conduction

(The following table shows the increment of thermal resistance R_{thJ-hs} when devices operate at different conduction angles than DC)

Conduction angle	Sinusoidal conduction		Rectangular conduction		Units	Conditions
	Single Side	Double Side	Single Side	Double Side		
180°	0.003	0.003	0.002	0.002	K/W	T _J = T _J max.
120°	0.004	0.004	0.004	0.004		
90°	0.005	0.005	0.005	0.005		
60°	0.007	0.007	0.007	0.007		
30°	0.012	0.012	0.012	0.012		

Ordering Information Table

Device Code							
1	2	3	4	5	6	7	8
ST	123	0	C	16	K	1	
1	-	Thyristor					
2	-	Essential part number					
3	-	0 = Converter grade					
4	-	C = Ceramic Puk					
5	-	Voltage code: Code x 100 = V _{RRM} (See Voltage Rating Table)					
6	-	K = Puk Case A-24 (K-PUK)					
7	-	0 = Eyelet terminals (Gate and Auxiliary Cathode Unsoldered Leads)					
		1 = Fast-on terminals (Gate and Auxiliary Cathode Unsoldered Leads)					
		2 = Eyelet terminals (Gate and Auxiliary Cathode Soldered Leads)					
		3 = Fast-on terminals (Gate and Auxiliary Cathode Soldered Leads)					
8	-	Critical dv/dt: None = 500V/μsec (Standard selection)					
		L = 1000V/μsec (Special selection)					

Outline Table

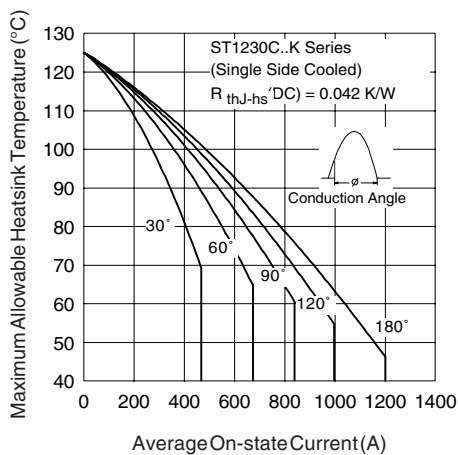
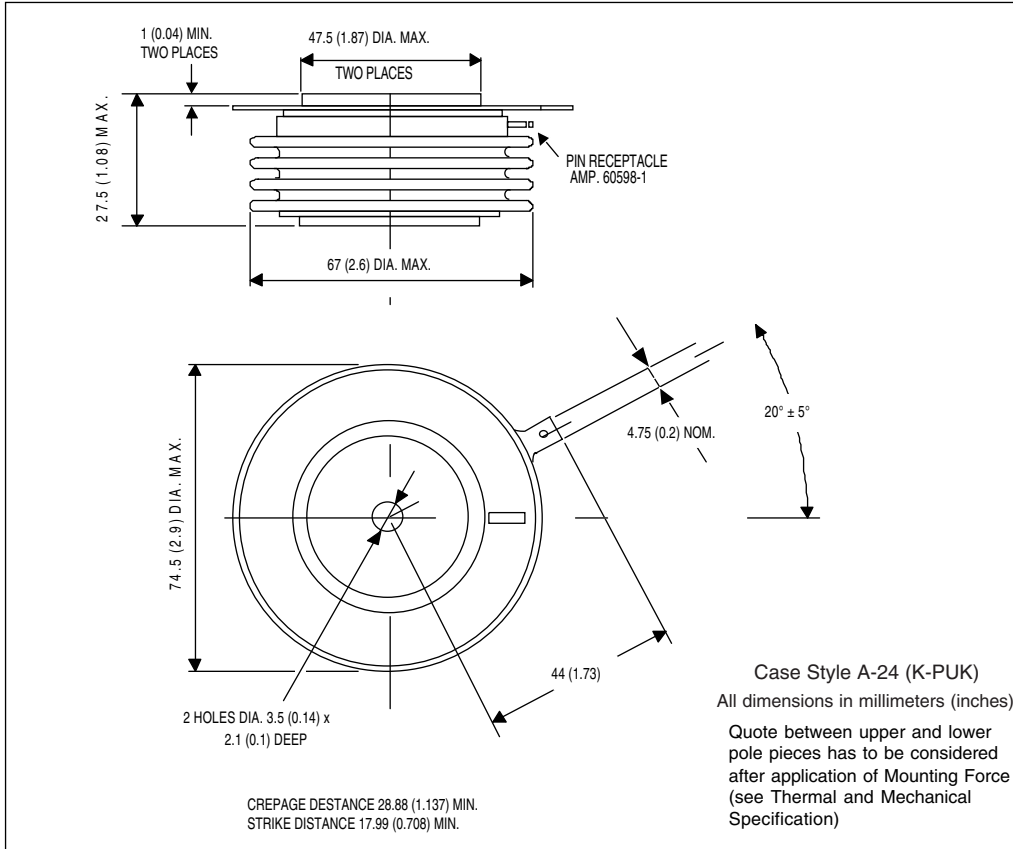

Fig. 1 - Current Ratings Characteristics

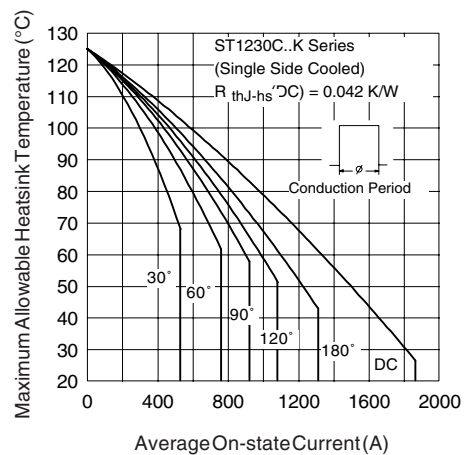

Fig. 2 - Current Ratings Characteristics

ST1230C..K Series

Bulletin I25194 rev. B 01/00

International
IRF Rectifier

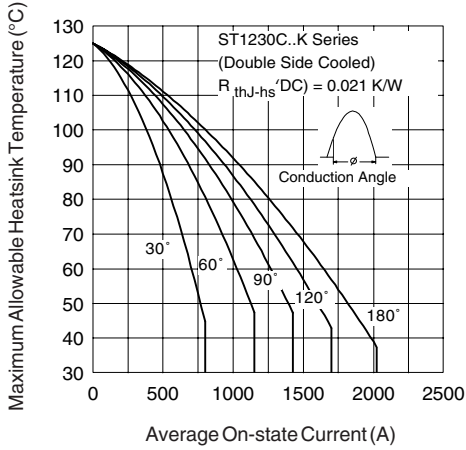

Fig. 3 - Current Ratings Characteristics

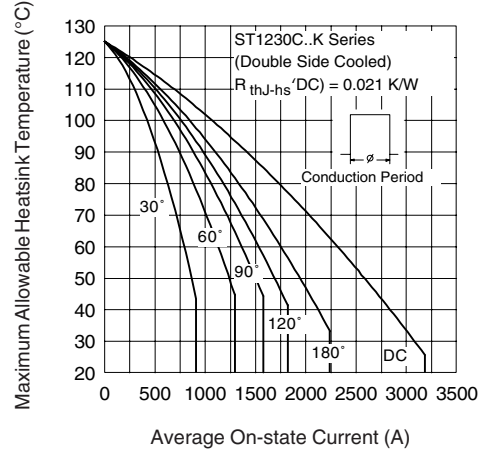

Fig. 4 - Current Ratings Characteristics

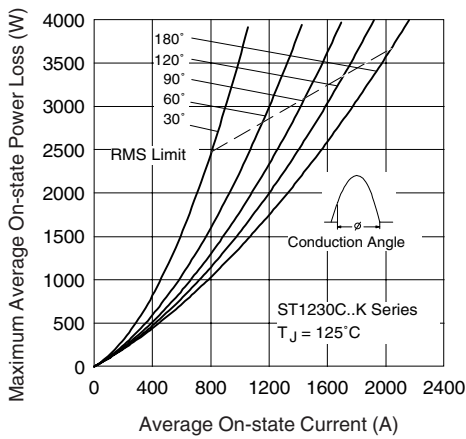

Fig. 5 - On-state Power Loss Characteristics

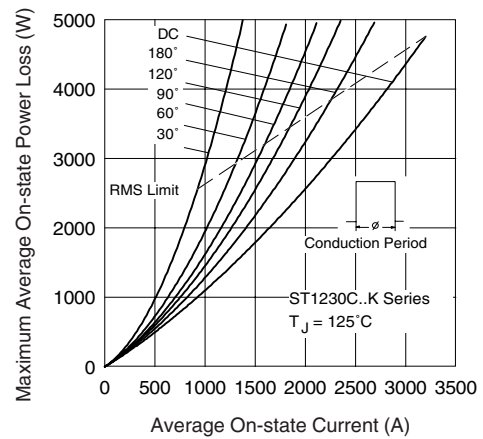

Fig. 6 - On-state Power Loss Characteristics

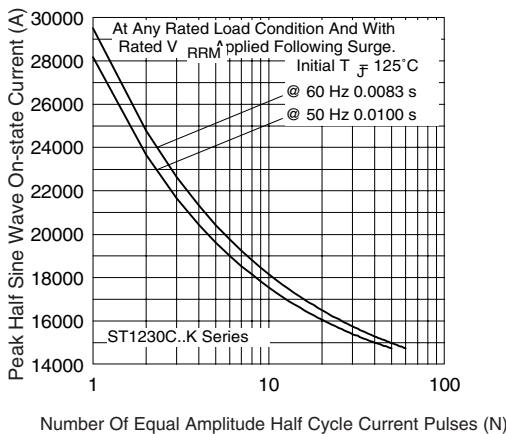

Fig. 7 - Maximum Non-Repetitive Surge Current Single and Double Side Cooled

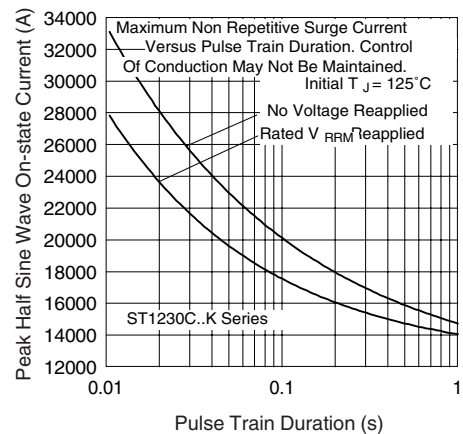

Fig. 8 - Maximum Non-Repetitive Surge Current Single and Double Side Cooled

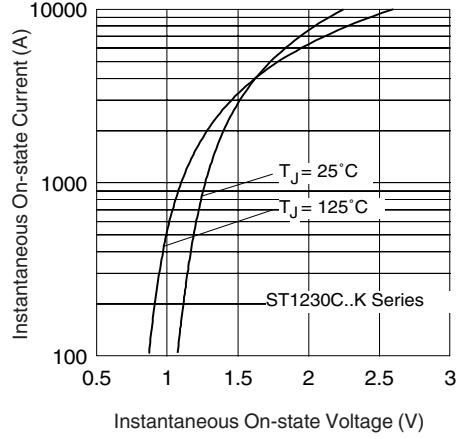

Fig. 9 - On-state Voltage Drop Characteristics

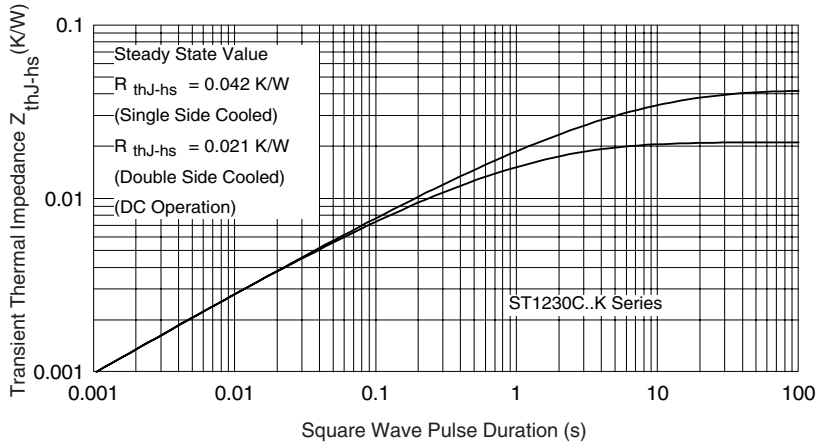

Fig. 10 - Thermal Impedance Z_{thJ-hs} Characteristics

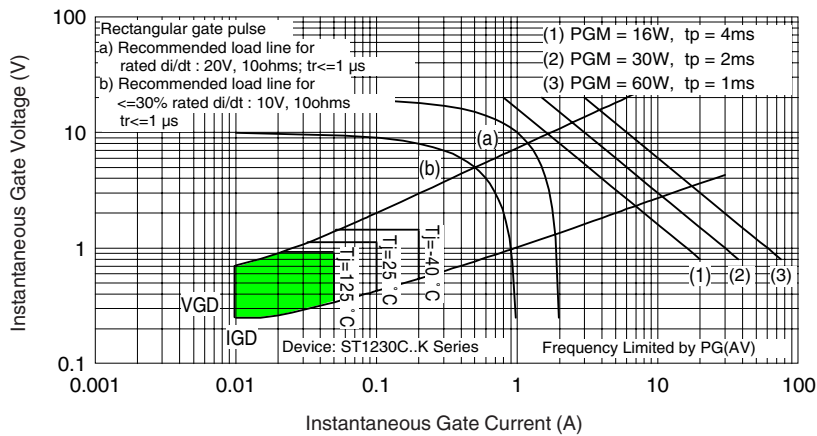

Fig. 11 - Gate Characteristics

This datasheet has been download from:

www.datasheetcatalog.com

Datasheets for electronics components.